



## Intelligent Electric Vehicle Chargepoints

7.4kW or 22kW Models



## Amendments

Amendment Number	Details	Date
Ver 1, Rev 0	New Document.	February 2023
Ver 1, Rev 1	Update to include instructions specific to Samsung phone users.	March 2023
Ver 1, Rev 2	Update to provide more detail on schematics.	March 2023
Ver 1, Rev 3	Update of Specifications information.	April 2023
Ver 1, Rev 4	Update Warranty Terms and Conditions	May 2023

<b>Product:</b>	<b>Intelligent Electric Vehicle Chargepoints</b>		
<b>Applicable Models:</b>	<b>1-Phase</b>	<b>3-Phase</b>	
	EVON0090 – <i>Socket Version</i>	EVON0100 – <i>Socket Version</i>	
	EVON0095 – <i>Tethered Version</i>	EVON0105 – <i>Tethered Version</i>	
<b>Document Type:</b>	Installation and Operation Manual		
<b>Document Code:</b>	QUBEVSM-V01-R4		
<b>Language:</b>	UK English (Original)		
<b>Date Published:</b>	May 2023		
<p>One Stop Europe Ltd are the publishers of this document and own the rights to use the text, images and all technical content contained within. Content supplied by third parties / partner organisations remains the property of that organisation and is used by agreement with the supplier.</p> <p>OneStop exercise care to ensure content is as accurate as possible at the time of publication. However, no guarantee of accuracy should be inferred.</p>			
<p>www.qubev.com            One Stop Europe Ltd            Ralphys Lane, Frampton West, Boston, Lincolnshire, PE20 1QU</p>			

## Contents

<b>Support</b>	<b>2</b>
<b>Safety</b>	<b>3</b>
Safety Advice within this Manual	3
<b>Product Features</b>	<b>4</b>
About Load Balancing	4
About Demand Side Response	5
About PEN Protection	5
<b>Product Specification</b>	<b>5</b>
Physical Specification	5
Electrical Specification	8
Certifications and Compliances	8
<b>Labelling</b>	<b>9</b>
<b>Unpacking</b>	<b>9</b>
Typical Contents	9
Typical Options	9
<b>Installation</b>	<b>10</b>
Before Installation	10
If a Mounting Post Will be Used	12
Schematic Diagrams	13
Installation Procedure	15
Install Load Balancing	18
Overview	18
Connect the CT to the Property	18
Connect a 3-Phase CT to the Property	19
Extend the CT Cable	19
Solar Integration	20
Connect the CT Cable to the Chargepoint	20
Configure Load Balancing	21
Install Cable Tidy/Hanger	22
Testing	23
Completion	23
<b>Application Setup</b>	<b>24</b>
Register	24
Add a Device	25
Remove a Device	26
Functional Check	27
Configure Load Balancing	28
Change the Load Balancing Setting	30
OCPP IP and ID Settings	31
<b>Operation</b>	<b>31</b>
Share a Connection	31
Charger Status Indications	33
Operational Indications	33
Fault Indications	33
Charger Button Functions	34
Charge a Vehicle	35
Charging Modes	35
Plug and Charge	35
Schedule Mode	36
Create a Schedule:	37
Delete a Schedule	37
ECO Mode	38
Other Application Features	39
Edit Charger Details	39
Record Screen	39
<b>Maintenance</b>	<b>40</b>
<b>Disposal</b>	<b>41</b>
<b>Warranty</b>	<b>42</b>

## Support

For assistance with the installation or operation of this product, contact your preferred electrical installer.

## Safety

This manual is provided as a guide to installation and operation and is specifically applicable to the QubEV Intelligent electric vehicle charger. Failure to install and operate the QubEV in accordance with these instructions may damage the unit and invalidate the manufacturer's warranty.



**IMPORTANT:** Installers and End Users **must** read and **understand** the content of this manual before installation and/or use of the product.

Installation must **only** be performed by someone who is properly qualified and competent to do so in accordance with the current legislation in force in the geographical location of the installation.

- The manufacturer/distributor cannot accept any responsibility for improper installation or any problems arising from improper installation.

**NOTE:** Damage to the equipment, connected systems or to property caused by improper installation are the responsibility of the installer.

- The information provided in this manual must **ONLY** be used with the model(s) listed on page 1 of this manual.
- The information provided in this manual must **NOT** be used with any other product.
- The content of this manual may be updated by the manufacturer as required.
- Do **NOT** use the equipment for anything other than its intended purpose.
- Do **NOT** modify the equipment unless specifically instructed to do so by the manufacturer.
- Do **NOT** attempt to repair the equipment unless specifically instructed to do so by the manufacturer.
- To maintain electrical safety, the body enclosure of the product (access covers) must be secured in their correct location using the supplied fasteners and the seal must be sufficient to maintain the IP rating of the enclosure.
- Fasteners used to mount the product in its working location must be sufficient for the task and the specific mounting point.
- If required, fasteners used to mount the product in its working location should be sealed to maintain the IP rating of the enclosure.
- Damage to the product may render it unsafe. The product must be electrically isolated and **NOT** used until appropriate remedial action has been performed.

## Safety Advice within this Manual

This manual uses a system of warnings, cautions and notes.

- **WARNINGS** concern the safety of installers/end user and will be given before the detail/instructions in the manual.
- **CAUTIONS** concern the potential for damage to the equipment and will be given before the detail/instructions in the manual.
- **NOTES** are given to provide additional information and/or to highlight information of importance. They will be given either before or after the detail/instructions as appropriate and may use different wording (such as **IMPORTANT**) where emphasis is required.

Warnings, Cautions and Notes may be repeated several times as appropriate and may be preceded by a hazard symbol where appropriate.

## Product Features

- Universal charging socket or Type 2 tethered lead
- Power rating – Up to 7.4kW or 22kW models
- Adjustable power rating – 10A, 13A, 16A & 32A
- Free QUBEV Smart Wi-Fi app
- Scheduled / off-peak charging
- Solar compatible\*
- PEN fault and residual current protection (AC 30mA Type A, DC 6mA)
- Dynamic load balancing (CT clamp(s) & cable(s) included)
- OCPP 1.6 compliant
- Built-in LED charging status indicator
- UK Smart Charge Point Regulations Compliant including tamper security
- Wi-Fi / Ethernet connectivity
- IP54 & IK08 rated
- Corrosion & fire resistant
- CE and UKCA certified
- Easy to install and maintain
- Wall or post mounting options
- 3 Year warranty

\*App dependent features:

**NOTE:** When detailing Load Balancing, this manual assumes the installation of a single chargepoint. Whilst multiple chargepoints can be connected in a similar way, installers may wish to consider connecting/monitoring using a third-party, compliant energy management solution.

If connecting/monitoring via third-party equipment, make sure you are fully aware of the manufacturer's instructions so that the device/system can be installed correctly and in conjunction with the chargepoint installation.

## About Load Balancing

This chargepoint has a **Load Balancing** capability which is designed to prevent overloads of the property's power supply when a vehicle is being charged.

Once correctly installed and configured, the system will monitor the power being drawn by the charging process and will compare this to the permissible maximum for the property as a whole (which is set as part of the configuration). With this information, the power made available for charging can be dynamically adjusted to reduce the load before the property's maximum load is exceeded.

### NOTES:

- Load balancing ONLY controls power made available to the VEHICLE. It does not control power to other equipment and it is still possible for that equipment to overload the property's power supply.
- Depending on the manufacturer, electric vehicles need a minimum of around 6 Amps to charge. If the available power is below this level, the vehicle may stop the charge session.
- The lower the power available for charging, the more slowly the vehicle will be charged.

## About Demand Side Response

Demand Side Response (DSR) is where the chargepoint and the electricity provider are in communication with each other. The electricity provider will control the chargepoint remotely via the chargepoint software to reduce the power it draws when it is needed by higher priorities in the area and will increase power when those priorities reduce.

If the chargepoint is used with a DSR agreement in place, peak and off-peak charging will not be implemented because the power company's systems will control the charging process.

## About PEN Protection

The PEN protection system removes the need to install a dedicated earth for the chargepoint although an earth is still required via the power cable.

In the event of a fault, the system will break all power cable connections between the chargepoint and the vehicle.

## Product Specification

### Physical Specification

Enclosure Dimensions	330mm x 200mm x109mm (H x W x D)
Enclosure Materials	PC/ABS Alloy
Mass	<ul style="list-style-type: none"> <li>• 2.5kg 1-Phase, Single Socket</li> <li>• 2.75kg 3-Phase, Single Socket</li> <li>• 4.7kg 1-Phase, Tethered Cable</li> <li>• 6.0kg 3-Phase, Tethered Cable</li> </ul>
Operating Temperature	-25°C to +50°C
Humidity	3%~95%
Altitude	<2000m
Protection	<ul style="list-style-type: none"> <li>• Ingress protection – Enclosure IP65, plug &amp; socket IP54</li> <li>• Impact protection – IK08</li> <li>• Security – Tamper and breach protection boundaries with notifications</li> </ul>

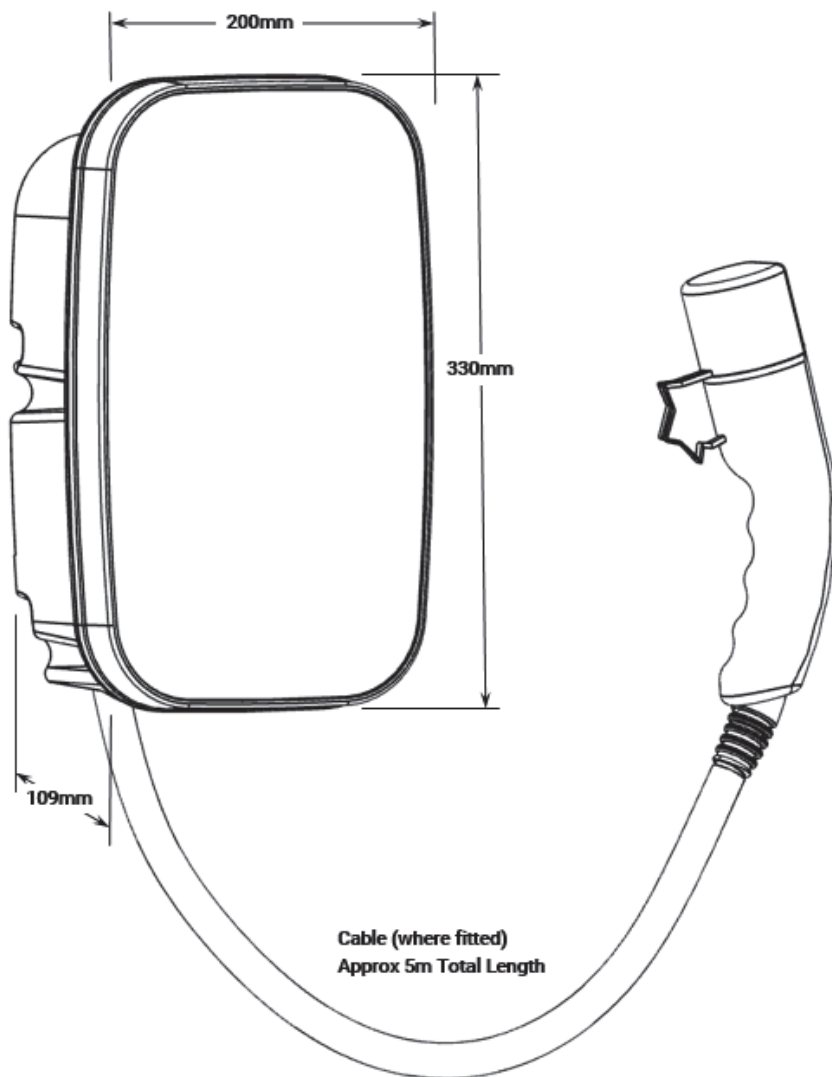

Figure 1 Enclosure Dimensions

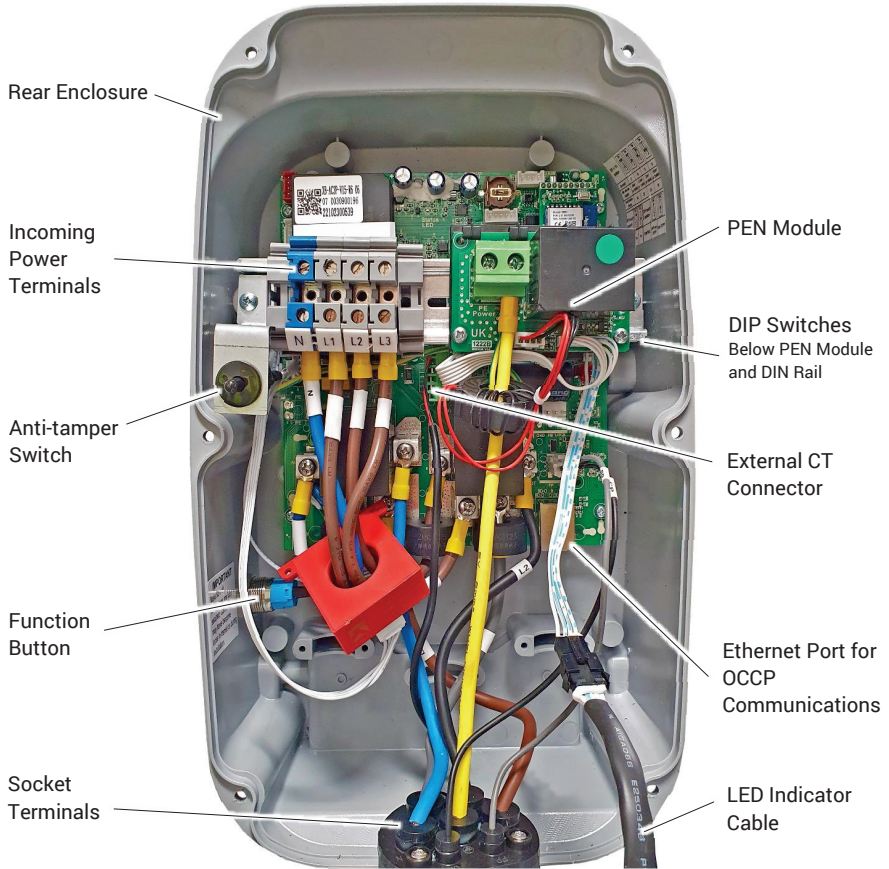

Figure 2 Internal Arrangement (3-phase, socket model shown)

**NOTE:** Except for the number of incoming power terminals, the internal arrangements of all models are very similar.



## Electrical Specification

	EVON0090	EVON0095	EVON0100	EVON0105
Description	Single Socket, Intelligent EV Charging Unit	5m Tethered Cable, Intelligent EV Charging Unit	Single Socket, Intelligent EV Charging Unit	5m Tethered Cable, Intelligent EV Charging Unit
Rated Output	Up to 7.4kW (32A)		Up to 22kW (32A)	
Input Voltage	AC 220V~240V 50/60Hz (1-phase)		AC380V~415V 50/60Hz (3-phase)	
Incoming Cable Terminals	3 x 10mm <sup>2</sup> terminals		5 x 10mm <sup>2</sup> terminals	
Charging Connection	IEC 62196 (Type 2)			
Charge Protocol	Mode 3			
Rated Current	Up to 32A max			
Charging Current	Variable – 10A, 13A, 16A, & 32A			
Protection	<ul style="list-style-type: none"> <li>• Over current protection – A suitably rated MCB to be installed at source is recommended.</li> <li>• Residual current protection – AC 30mA Type A &amp; DC 6mA</li> <li>• Over temperature protection</li> <li>• PEN fault detection</li> </ul>			
Communications	<ul style="list-style-type: none"> <li>• Wi-Fi 802.11 b/g/n 2.4 GHz</li> <li>• RJ45 Ethernet connection</li> <li>• Bluetooth (for installer configuration purposes)</li> <li>• OCPP 1.6J</li> </ul>			
Standby Power Consumption	<10W			

### NOTES:

1. Tethered cables are approximately 5m total length.

## Certifications and Compliances



This product has been designed and built in accordance with the following standards and legislation:

EV Charging Compliance	EN IEC 61851-1:2019, BS EN IEC 61851-1:2019. Smart Regulations SI 2021:1467 inc Schedule 1.
EMC Compliance	2014/30/EU, SI 2016:1091. ETSI EN 301 489-1 V2.2.3 (2019-11) ETSI EN 301 489-3 V2.1.1 (2019-03), ETSI EN 301 489-17 V3.2.4 (2020-09). IEC 61851-21-2:2018. EN IEC 61851-21-2:2021.
Radio Emissions	2014/53/EU, SI 2021:1467. ETSI EN 300 328 V2.2.2, ETSI EN 300 330 V2.1.1. ETSI EN 301 489-1 V2.2.3, ETSI EN 301 489-3 V2.1.1. ETSI EN 301 489-17 V3.2.4, EN IEC 61851-21-2:2021. EN IEC 61851-1:2019, EN IEC 62311:2020. BS EN IEC 61851-21-2:2021, BS EN IEC 62311:2020.
Safety Compliance	EN 60950-1:2006+A2:2013, EN 60950-22:2017. IEC 62955:2018.
Low Voltage Directive (LVD)	2014/35/EU, SI 2016:1101.

## Labelling

Observe any/all warning labels displayed on or inside the enclosure.

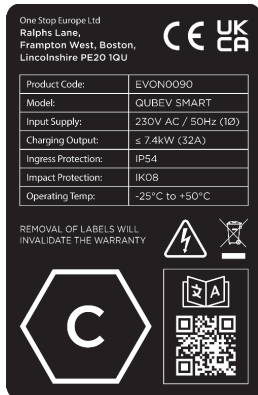

Figure 3 Typical Product Label



Figure 4 Typical Serial Number Label Includes Month and Year of Manufacture



Figure 5 Terminal Security Label

**NOTE:** The Connection Type marking (hexagon) is shown on the charger of socket models, and on the plug of tethered cable models.

## Unpacking

The content of the package depends on any options or accessories that may have been selected.

**IMPORTANT:** Make sure all packaging is disposed of responsibly and in accordance with the current regulations in your region.

## Typical Contents

- 1 x EV Charging Device and Fixing Bracket.
- 1 x Installation and Operation Manual.
- 1 x Hex Wrench.
- 4 x Wiring Ferules.
- 1 x Cable Gland and Rubber Sealing Grommet.
- 1 x Charger Fixing Kit (4 x Fixings and Wall Plugs).
- 1 x Cable Tidy/Hanger and Fixings (Tethered Cable Chargers Only).
- 1 x Load Balancing CT Device.
  - 1 x Load Balancing CT Device Terminal Block.
  - 1 x Load Balancing CT Device Rubber Sealing Grommet.

## Typical Options

- EV charging cables (Type 1 to Type 2 or Type 2 to Type 2).
- Charge point signage.
- Type A Residual Current Circuit Breaker (RCBO).
- Enclosure for Residual Current Circuit Breaker.

## Installation



**IMPORTANT:** Installers and End Users **must** read and **understand** the content of this manual before installation and/or use of the product.

Installation must **only** be performed by someone who is properly qualified and competent to do so in accordance with the current legislation in force in the geographical location of the installation.

- Advice provided in this manual does NOT replace any legislation.
- The manufacturer/distributor cannot accept any responsibility for improper installation or any problems arising from improper installation.

**NOTE:** Damage to the equipment, connected systems or to property caused by improper installation are the responsibility of the installer.

## Before Installation

1. Discuss with the customer where the chargepoint is to be installed. This may affect whether the electrical power cable will enter the unit from below or behind the enclosure.
  - Cable entry through the left, right or top of the enclosure is NOT recommended.
  - If Load Balancing will be implemented, the charge point should, ideally, be within the reach of the Load Balancing Device cable which must be connected between the chargepoint and the property's main consumer unit (fuse box). Load Balancing Device cables can be extended if required.
  - If Load Balancing will be implemented, plan the installation of the Load Balancing Device alongside the installation of the chargepoint. Information about installing load balancing is shown after the chargepoint installation.
2. Identify an installation location for the unit that is both secure and environmentally safe.
  - If installing a tethered cable version of the charger, also decide where the cable tidy/hanger will be mounted.
  - Whilst the chargepoint is weather resistant in accordance with the required standards, a location that is sheltered from weather extremes will help to maintain that resistance.

**NOTE:** For ease of access, it is suggested that there is a minimum of 250mm free space on both the left and right-hand sides of the chargepoint when it is installed.

**NOTE:** This unit is NOT suitable for use in locations where there are high amounts of dust, or in an explosive or flammable environment.

3. Make sure the charger will be mounted at an accessible height, that access to the charger is not restricted, and that the charger does not restrict access to other parts of the property.
4. Consider the distance between the charger and the vehicle(s) that will be charged.
5. Make sure the location meets current legislation (if applicable).
6. Make sure there is a suitable electrical power supply available at the installation site.

7. If required, make sure there is an ethernet cable connection available at the installation site.
8. If required, make sure wireless communications signal strength is available at the installation site.
  - Wireless communications need to be strong and stable.
  - If using Wi-Fi from the property a booster and/or outdoor antenna may be required on the property to provide sufficient signal strength.
9. Determine the output power of the charger paying consideration to the incoming power supply and any other factors that may limit the power available for charging.
  - Output power can be adjusted by setting the DIP switches as instructed during charger installation.
10. Determine the rating of the property main fuse/circuit breaker. This will be needed to set up load balancing.



**IMPORTANT:** Write the fuse rating in the space provided on the rear cover of this manual.

11. Determine whether the charger will be controlled by the 'Application and OCPP' or to only to OCPP.
  - The type of connection can be adjusted by setting the DIP switches as instructed during charger installation.
12. Make sure the unit model is correct and matches the order.
13. Make sure the unit and any accessories do not appear to have been damaged in transit.
14. Make sure the supplied fixings are suitable for the mounting location. If not, alternatives must be obtained before proceeding with the installation.

**IMPORTANT:** This product does not contain its own electrical protective device or a physical energy meter. If required, these devices must be installed externally.

15. Make sure any additional electrical protective devices (such as an MCB, RCD or RCBO) required by regional legislation, have been correctly installed to the power supply that feeds the charge point.
16. If an independent form of energy monitoring is required, a meter should be installed to the power cable that feeds the charge point. Similarly, if solar power is used, a meter may also be installed to the power cable feeding the charge point from the solar supply.

## If a Mounting Post Will be Used

1. Prepare the ground and place the mounting post in the desired location.
  - Make sure the power supply cable, the ethernet cable (if required), and the Load Balancing CT cable (if required) are fed upward through the tube of the post and exit through one of the apertures. Seal other apertures with the provided blanking panels.

**NOTE:** The ethernet connection within the charger is solely for connection to an OCPP back-office. It is not for use with the Smart Application.

2. If required, secure the post in place with fixings that are appropriate for the mounting surface.
3. When mounting the charger to the post, the charger mounting bracket must first be attached to the plate on the post using the pre-drilled holes and supplied fasteners. The charger can then be secured onto its mounting bracket at the appropriate point of the installation.

Schematic Diagrams

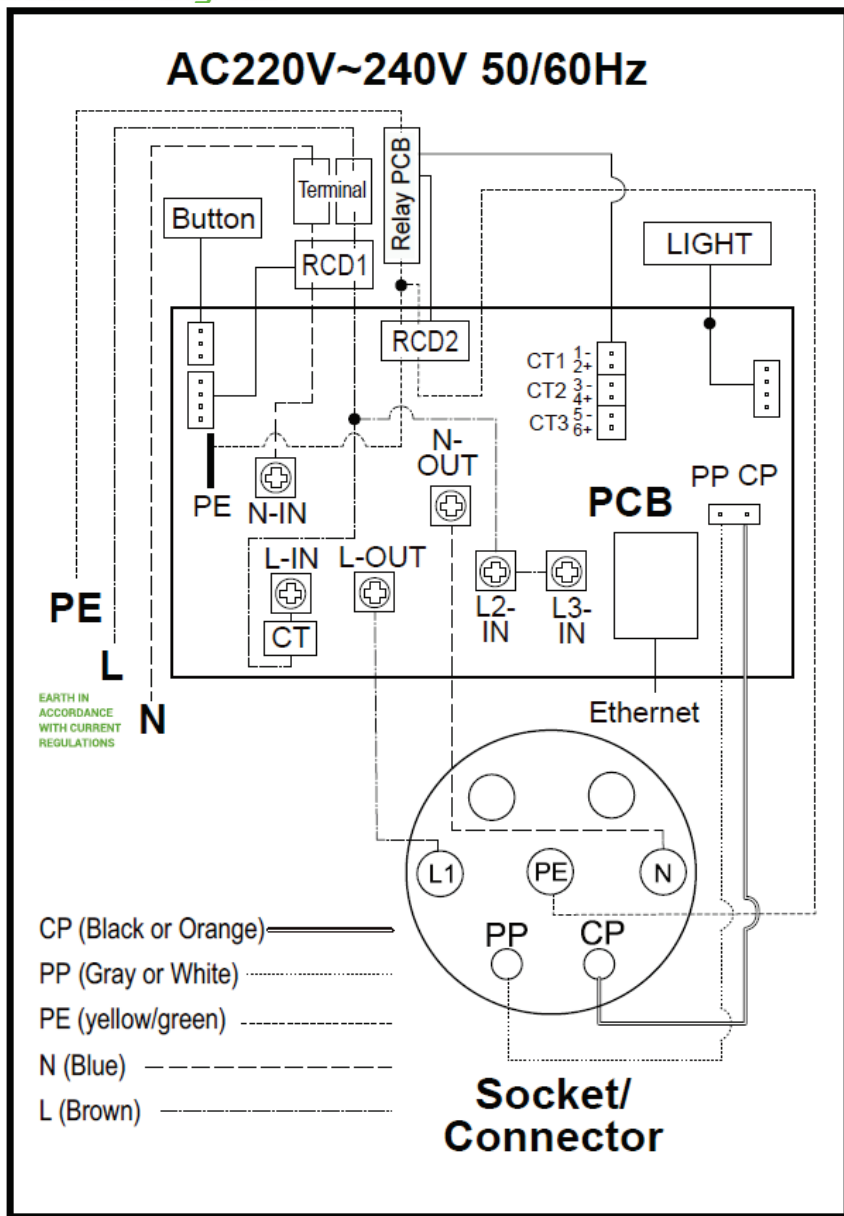

Figure 6 EVON0090 -1-Phase, Version Schematic Diagram

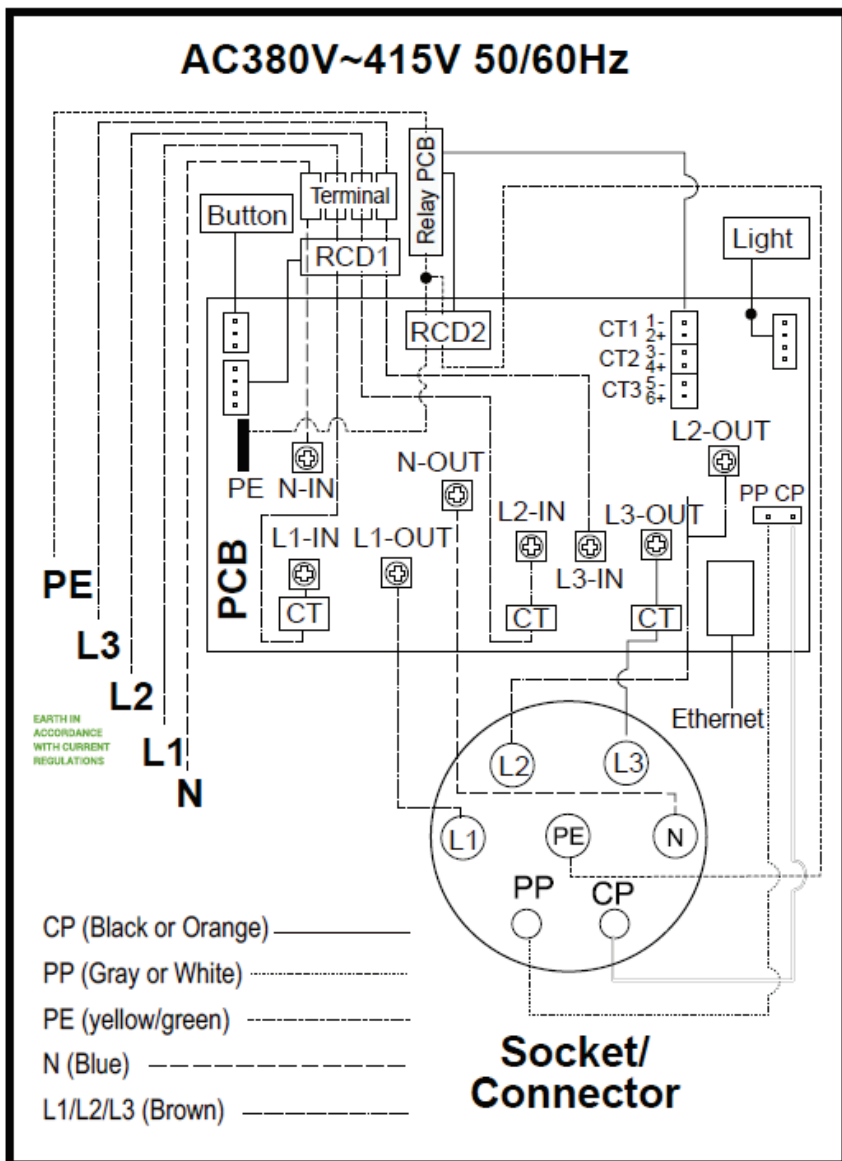

Figure 7 EVON00100 - 3-Phase, Version Schematic Diagram

## Installation Procedure

**NOTE:** All electrical work must be performed in accordance with the applicable Electrical Wiring Regulations for the region of use.

**NOTE:** If load balancing will be enabled on this charge point it should, ideally, be installed alongside the 'standard installation'. Refer to **Install Load Balancing** on page 18.

**CAUTION: Equipment Damage**

During the next steps, the charger front panel will be removed. Take care to not damage or strain cables or cable connections that may pass between the enclosure and the front panel.

1. Remove the QUBEV Smart from the packaging.
2. Release the fixings that secure the front panel to the rear enclosure.
3. Carefully lift the front panel away from the rear enclosure to access to the interior.

**CAUTION: Equipment Damage (Socket Versions)**

The front panel is connected to the charger by electrical cables. Take care not to damage, strain, or disconnect the cables. At the end of the procedure, make sure all connections are secure before refitting the panel.

4. Visually inspect the QUBEV Smart and internal components.
  - Any components that may have come away from the DIN rail in transit must be refitted to the rail if there is no damage to the component or its securing mechanism.

**IMPORTANT:** Items damaged in transit must first be reported to the courier and then to the supplier.

- Where possible, photographic evidence of package and/or unit damage should be provided.
- Incorrect or damaged units must NOT be installed. Contact your supplier to discuss rectification.

5. Make note of the location of the incoming power terminals within the enclosure. This will help when positioning the unit to match the customer's needs.
6. Remove the mounting bracket from the packaging or, if already mounted to the charger, remove the 4x securing bolts from the bracket then removed the bracket from the charger.
  - The securing bolts will be required when the charger is mounted back onto the bracket.

**NOTE:** If the charger will be post mounted, secure the mounting bracket to the plate on the mounting post using the fasteners provided then move to step 11.

7. Use the mounting bracket to mark the mounting positions.
  - Place the mounting bracket onto the mounting location (wall).
  - Make sure the bracket is flat against the wall and is orientated correctly and is level.
  - Mark the 4 fixing holes onto the surface of the wall.
  - If the power supply cable, CT cable, ethernet cable, etc. will be coming through the wall, mark the appropriate cable aperture(s).
8. Drill the 4x marked fixing holes in the wall and insert the wall plugs.



9. If required, drill the wall for at the cable aperture locations.
10. Secure the mounting bracket to the wall with the 4x screws from the fixing kit.
11. Cut a neat hole in the charger body to allow entry of the power cable and the cable sealing gland.
  - Ideally, the cable should enter the unit from below or through the back of the enclosure.
  - A suitable cable gland must be used to maintain the IP of the unit.
  - If a CT and/or ethernet communications will be used, space may be required for additional holes and cable glands.
12. Make sure any installation debris is removed from the charger enclosure and the internal components.
13. If required, adjust the charger output power using the DIP switches.

**Factory Default = 32Amps.**

- The DIP switches are located behind the PEN module which may need to be temporarily removed for access. To gain access...
  - remove the securing screw from each end of the DIN rail that holds the PEN module and the incoming power terminals.
  - carefully lift the DIN rail and the attached components away.
- Set the DIP switches to the required **Current(A)** as indicated in the illustration below.

DIP switch position				
Current(A)	32	16	13	10
Min. wire size (copper)	6mm <sup>2</sup> or 10AWG	2.5mm <sup>2</sup> or 13AWG	2mm <sup>2</sup> or 14AWG	1.5mm <sup>2</sup> or 15AWG
Circuit breaker (Amps)	40	20	20	16

DIP switch position			DIP switch position		
Earth check	Yes	No	CONTROL	APP and OCPP	Only OCPP

Figure 8 DIP Switch Positions

14. Make a record of the Amps setting here.

<b>Amps:</b>	<b>Signature:</b>	<b>Date:</b>
<b>Name:</b>		

15. If required, set the Control method DIP switch to **App and OCPP** or to **Only OCPP**, as shown in the illustration above.

**Factory Default = App and OCPP.**

16. Refit and secure the DIN rail and components.
  - After fitting, make sure the components are securely attached to the DIN rail.
17. Carefully place the charger body temporarily onto the mounting bracket so that cable lengths can be determined.

**NOTE:** All electrical work must be performed in accordance with the current Electrical Wiring Regulations that are applicable in the region of installation.

**CAUTION: Equipment Damage – Sensitive Equipment**

If you will be performing insulation resistance tests on the power supply cables, it is advised to be done BEFORE connecting the cable to the charge point. The high voltages applied during the test may damage sensitive components if tested after the cable is connected.

18. Determine the most suitable cable routing and the cable length of all cables that will enter the enclosure so that each cable can connect to the appropriate terminal(s).
  - Cable routing may depend on the cable entry point(s) into the enclosure and the type of cable used.
19. Terminate the supply cable in the appropriate manner and connect it to the charge point as per the schematic.
  - 1-phase models will use the terminals L1, N and E (PE).
  - 3-phase models will use the terminals L1, L2, L3, N and E (PE).

**NOTE:** The ethernet connection within the charger is solely for connection to an OCPP back-office. It is not for use with the Smart Application.

20. If required, connect the ethernet cable and the CT cable to the charger.
  - If the supplied rubber gromets will be used, the rubber may need to be carefully cut to enable the ethernet cable to be fitted.
  - The ethernet connector and the CT connector locations within the enclosure are shown at Figure 2 on page 7.
  - Details about CT installation are shown on page 19.
21. Make sure ALL accessible cable connections are secure and have not become loose or damaged in transit or during installation.
22. Make sure ALL debris is removed from the enclosure and that no debris is present on any of the components.

**IMPORTANT NOTE:**

It is the responsibility of the installing engineer to make sure that all accessible cable terminations throughout this product are secure and tight and have not become loose, strained, or disconnected during transit and/or installation.

## Install Load Balancing

**NOTE:** This manual assumes the installation of a single chargepoint. Whilst multiple chargepoints can be connected to a property in a similar way, installers may wish to consider connecting/monitoring via third-party equipment.

If connecting/monitoring via third-party equipment, make sure you are fully aware of the manufacturer's instructions so that the device/system can be installed correctly and in conjunction with the chargepoint installation.

If load balancing will be enabled on this charge point it should, ideally, be installed alongside the 'standard installation'.

If installing at a later date, work may be required to enable entry of the Current Transformer (CT) cable into the chargepoint enclosure.

### Overview

Power coming into the property is monitored by a Current Transformer (CT) that clamps around the property's incoming power cable and is then connected to the chargepoint.

- The CT has a cable allowing it to be connected to the chargepoint.
- Additional cable may be added to the CT cable but to maintain a good signal, it is recommended that cables extensions are kept as short as possible.

### Connect the CT to the Property

Do not use third-party CTs. They may not be compatible with the system and the point at which load balancing will take place cannot be guaranteed.

1. These instructions are for a single current transformer (CT) used with a 1-phase charger. Connection of CTs used with a 3-phase charger is very similar and is explained below this section.
2. The CT clamp should be positioned around the **Live** (positive) cable between the Meter and the Consumer Unit.
  - The **arrow** shown on the CT clamp must point in the direction of electrical flow TOWARD the consumer unit.
  - Alternatively, if required, the CT clamp may be positioned on the Negative cable leaving the Consumer Unit. The arrow on the CT clamp must point in the direction of electrical flow AWAY from the consumer unit.
3. Release the clip on the CT clamp then open the clamp.
4. Place the CT clamp around the L1 cable.
  - Make sure the arrow on the clamp points in the correct direction.
  - No other cables should pass through the CT clamp.
5. Close the CT clamp and secure it with the clip.

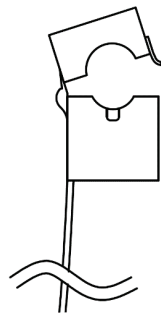

Figure 9 Typical CT Clamp

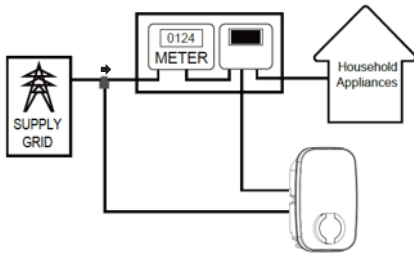

Figure 10 Single-Phase System CT Clamp Positioning

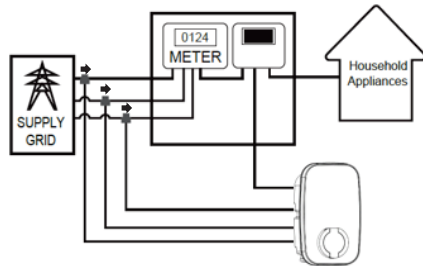

Figure 11 three-Phase System CT Clamp Positioning

### Connect a 3-Phase CT to the Property

3-Phase electrical supplies have 3x Live cables (L1, L2 & L3).

This means that for a 3-phase system where load balancing is required, a CT clamp must be installed around each one of L1, L2 and L3.

Unlike a 1-phase system, connecting the CTs to the neutral cable will not allow the system to function correctly as there are 3 CTs and only 1 Neutral cable.

1. Connect a CT cable clamps to each of L1, L2 and L3 as illustrated above.

### Extend the CT Cable

If required, a CT cable may be extended up to a theoretical maximum of 100m.

- To avoid interference and reduce the loss of signal, extension cables should be as short as possible. Extensions of 20m or less are recommended.
- Extension cables **must** be a screened 'Twisted Pair'. A screened twisted pair within a CAT6 computer network cable may be used.

**NOTE:** Twisted pairs within a CAT cable are indicated by their matching colours.

Do NOT use conductors of different colours, to extend a cable; interference may be induced.

If extending more than one CT, use a different colour pair for each CT.

### Solar Integration

The charger can be used to charge a vehicle using only solar power or using a combination of solar power and power from the grid.

A Current Transformer (CT) device must be connected between the solar system and the charger to monitor and control to supply of power to the charger from the solar system.

**NOTE:** CT connections used with a solar system are only possible with single-phase models of the charger. Three-phase models already use all the available connections.

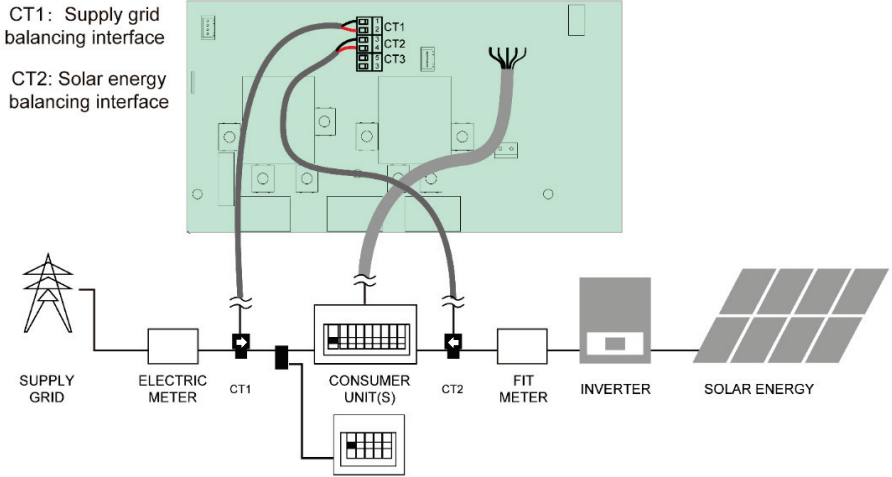

Figure 12 Solar CT Monitoring

**NOTE:** Arrow on the CT(s) must point in the direction of electrical flow and as shown above.

### Connect the CT Cable to the Chargepoint

**IMPORTANT:** A suitable cable gland must be installed to the chargepoint enclosure to accept the CT cable(s) and maintain the IP rating of the enclosure.

1. Connect one CT clamp wires to the screw-down connector plugs as shown opposite.

**NOTE:**

If extending the CT cable, the cable colours will be those that you have chosen to use.

2. Attach the connector to the charger.
  - If connecting to a single-phase charger, the plug should be connected to the two TOP terminals of the connector mounted on the PCB.

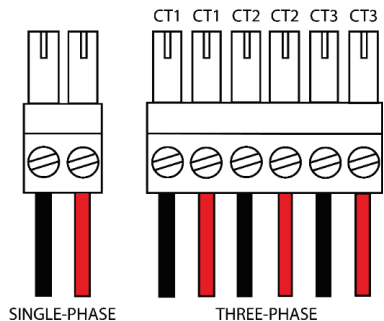

Figure 13 Load Balancing CT Connection

- In the image shown opposite a single CT is shown connected.
- For a 3-phase charger, all of the CT terminal positions would normally be connected.

Incoming Power Terminal  
1 of 4 (three phase)

Incoming Earth Terminal

CT Connector Block

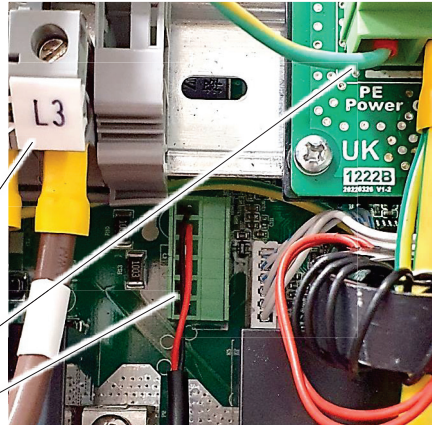

Figure 14 CT Connector Block

#### IMPORTANT: Plug and Socket Alignment

Make sure the plug and socket are correctly aligned. It is possible to make an incorrect connection where, plug terminal 1 for example is connected into socket terminal 2, and plug terminal 2 for is connected into socket terminal 3, and so on.



Figure 15 Incorrect Connection

**NOTE:** If solar power is available, a CT from the solar system can also be connected to the CT Connector Block (single phase systems only). Refer to **Solar Integration** on page 20.

### Configure Load Balancing

Configuration of the load balancing system is performed using the Smart Application as part of the online configuration process. If you (the installer) are not configuring load balancing, make sure the rating of the property main fuse/circuit breaker is written on the rear cover of this manual so that load balancing can be set up by the user.

The main fuse or circuit breaker in the property's consumer unit should be labelled to state the maximum load. The load balancing system **must** be set to the same figure (or lower) than that of the main fuse or circuit breaker.

- Do NOT set load balancing above the maximum point. Load balancing will not initiate and all power to the property will be lost if the maximum point is reached.

**NOTE:** Load Balancing only limits the power available to the charger. It may still be possible to exceed the maximum permitted load of the property if too many appliances are used at the same time.

## Install Cable Tidy/Hanger

1. The charging cable on tethered chargers is permanently attached to the unit and must be stored correctly to help ensure long and trouble-free service.
2. Identify a mounting location that is close to the charger and that will support the weight of the cable.
3. Use the hanger as a template to mark the 4x fixing points on the mounting location at an accessible height.
4. If required, drill the marked fixing points, and insert wall plugs into the holes.
5. Secure the hanger to the mounting location with the screws provided or with screws that are suited to the location

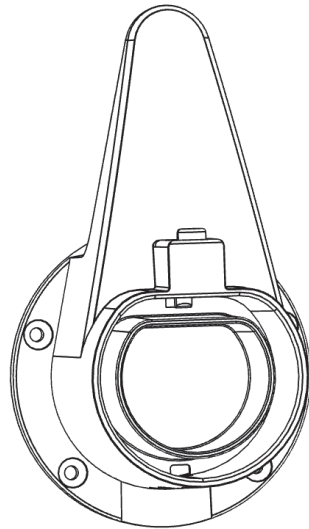

Figure 16 Cable Tidy/Hanger (Holster)

6. To remove the plug from the dummy socket, press the button and pull the plug away from the dummy socket at the same time.

---

## Testing

**WARNING: Electrical Power**

Testing may require power to be applied whilst the front panel fascia is removed. If this is not required, replace the front fascia NOW and secure it with the bolts removed at the start of the installation. Take care not to trap any electrical cables.

1. Make sure all accessible terminals/wires are secure and have not become loose or detached during the installation.
2. Make sure there is no installation debris inside the enclosure.
3. Test the installation in accordance with the current Electrical Wiring Regulations that are applicable for your region.
  - If required, refer to the Application Setup section for functional testing.
  - Make sure this product has been installed in compliance with the current Electrical Wiring Regulations (including recommended earthing arrangements).

## Completion

1. Make sure you are satisfied that the installation is complete and is in a safe condition.
  2. If not already installed, fit the front fascia to the charger and secure it with the bolts removed at the start of the installation. Take care not to trap any electrical cables.
  3. Fit and secure the charger to the mounting bracket.
  4. A functional test of the charger can be performed during Application Setup.
-



## Application Setup

These instructions assume the installer will perform initial configuration of the charger at the time of installation, but this may not always be the case and configuration may need to be performed by the user (the charge point App account holder) when, for example, taking possession of a property.

If Load Balancing is to be used and has not been configured by the installer, it should be configured by the charge point App account holder. If not configured, the default settings will operate Load Balancing with a 45Amp limit which may result in slower charging of the vehicle. Refer to **Configure Load Balancing** on page 28.

**IMPORTANT:** Wi-Fi signal strength at the charge point location must be sufficiently strong to make a reliable connection. Weak connections may result in data loss, slow speeds, transmission dropouts, etc.

If Wi-Fi is not sufficient, users may consider moving their wireless access point and/or adding a signal repeater, or booster, and/or external antenna. Contact your provider if further assistance is required.

- As a simple check of signal strength, check the number of Wi-Fi bars shown on your phone (when connected to the same access point) at the charge point location. 2 bars is the very minimum required.
- You will need the Wi-Fi name and password of your access point during this procedure. This can often be found on the back or bottom of the access point/router.

**NOTE:** The Smart application may be subject to updates. The App screens show in the following pages are representative and screens may change or appear different depending on the mobile device being used. The most recent changes may not yet be shown here but the overall operation of the application should be very similar.

## Register

1. Download the application (App) from the Apple App Store or from Google Play (as appropriate to the mobile phone being used).
2. When the application has installed itself to the phone, Open the application and register for an account. Registration can be achieved with either your...
  - Mobile phone number
  - Email address



**NOTE:** Only one account can be registered to a charger.

The link between the installer's account and the charger will be removed when the owner links their own account or may be removed by the installer before handing over to the owner. Refer to **Remove a Device**.

## Add a Device

1. Log into the application using the details entered during registration.
  - Read the application agreement then select the 'I Agree' check box to accept the terms and continue to use the app.
2. Press and hold the function button on the charger for 10s (beep x2) to reset the Wi-Fi.

### NOTES:

- Make sure the charging cable is NOT connected to the vehicle before moving to the next step.
- Make sure the mobile phone is close to the charger before moving to the next step.
- Make sure the phone's **Wi-Fi**, **Bluetooth** and **Geolocation** are turned ON.
  - If these services are not on, the application will alert you to this during the next steps.

### IMPORTANT: Samsung Phone Users

In the following steps, if the charge point does NOT find 'Nearby Devices', an on-screen alert message will be displayed to 'Turn on Bluetooth'.

- Make sure Bluetooth is turned on in the phone's normal settings.
- Tap the message **Allow 'Nearby Devices' Permission – Go to Set.**
- Tap **Permissions.**
- Tap **Nearby devices.**
- Tap **Allow.**
- Go back to the App's Home screen and attempt to **Add a Device**. The device should now be visible and able to connect to the charge point.

3. Tap the **Add Device** button on the phone screen to add the charger device that needs to be connected.
  - The application will automatically search for the charger.
4. The application will display the charger(s) it has found during the search.
  - If the charge point does not appear as a nearby device and an onscreen alert message is displayed stating to 'Turn on Bluetooth' follow the steps in the Note above.

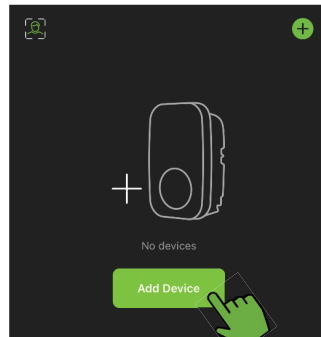

Figure 17 Add Device Screen

5. Select the appropriate chargepoint then tap the **ADD** button on the phone screen.

6. Enter the Wi-Fi name and password of the access point onto the screen.
  - You may need to get these details from the customer.
  - Make sure to add the details exactly as they are shown. They are often case sensitive.
7. Wait for the application to add the chargepoint.
8. A 'success' screen will be shown.
9. If required, the charge point name can be edited by tapping the **pencil** icon (✎).

  - Alternatively, tap the **Done** text button to access the default Home screen of the application.

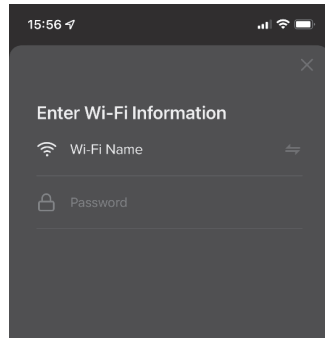

Figure 18 Enter Login Details

## Remove a Device

After performing all the setup tasks, the installer should disconnect from the charger to make it available for the customer.

1. Tap the **Pencil** icon to access the chargepoint details screen.
2. At the bottom of the screen, tap the **Remove Device** text. You will be presented with three options:
  1. Disconnect
  2. Disconnect and wipe data
  3. Cancel
3. Tap the **Disconnect** text.
  - Do NOT select Disconnect and wipe data. This option will remove the settings entered into the charger.
4. If you are happy to proceed, tap **Confirm** on the message pop-up that is displayed.
  - The screen will close and return you to the Add Device screen.

Alternatively, the link to the charger can be disconnected when assisting the customer to setup their connection to the charger:

1. Make sure the customer has their Wi-Fi details and password ready for entry into the application.
2. Press and hold the button on the side of the charger for approximately 10s (beep x2).
  - This will reset the Wi-Fi connection, removing the installer and allowing a new mobile (the customer) to connect.
  - Settings made during the setup process should still be present.

## Functional Check

- When first connected, the Home Screen will be shown and will present the options to...
  - select default mode.
  - edit the charging time.
  - select Plug and charge mode.
- Select **Plug and charge mode**.
- Connect the charge point to the vehicle.
- Tap the **Enable** button to START charging.
  - The charge point will start vehicle charging after a randomised delay of up to 10 minutes.
  - The Charging State shown on-screen should change to indicate charging is in progress.
- Tap the button again to STOP charging.
  - The charge point should stop charging the vehicle.
- The Charging State shown on-screen should change to indicate the charger is **Idle**.

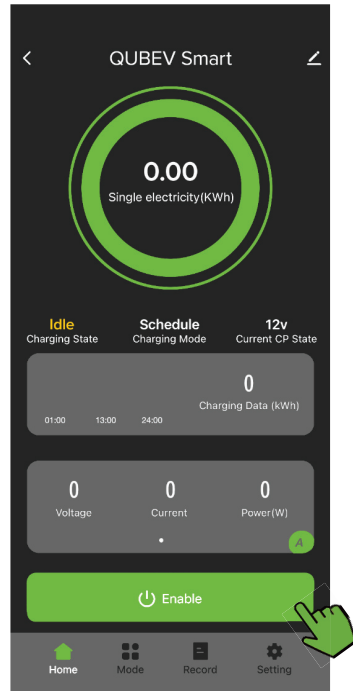

Figure 19 Home Screen

## Configure Load Balancing

**IMPORTANT:**

Load balancing figures should be entered when first setting up the charger to load balance the power used by the charger.

If the **Input order** (load balancing property fuse rating) is entered incorrectly, the device will still beep twice, but the order will not be executed. The incorrect Input order cannot be corrected until you disconnect device from the APP and wipe the data and connect it again. This is also the case if the property fuse rating is changed at a later date.

1. On the Home screen, tap the **Setting** icon.



- The screen will change to show the setup options.

2. Ignore any entries that may already displayed on screen. The figures shown will not take effect until tapping to confirm the new entry.

3. Tap the **Input orders** label.

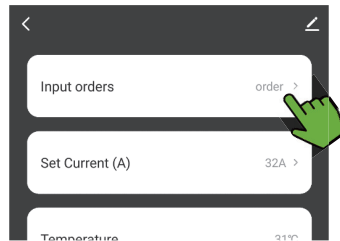

Figure 20 Input Orders Selection

4. Enter on the screen, **HOME** followed by value of the property fuse (main breaker). For example, **HOME80**, for an 80A fuse.

- Setting range is 08-120.

5. Tap **Confirm** to enter the figure into the system. The charger will beep twice to acknowledge the setting.

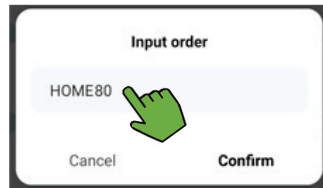

Figure 21 Load Balancing Amp Setting Text

If the setting is entered incorrectly or must be changed. Refer to **Change the Load Balancing Setting** on page 30.

- An incorrectly entered setting may be indicated by an orange exclamation icon.



Figure 22 Incorrect Setting Indication

6. Tap the **Set Current (A)** label.
7. Ignore any entries that may already displayed on screen. The figures shown will not take effect until tapping to confirm the new entry.
8. Select on the screen, the maximum current that will be drawn by the charger.
  - This must be the same as the setting made with the DIP switches inside the charger and should be shown on the back of this manual.
  - Setting range is 6 - 32A.
9. Tap **Confirm** to enter the figure into the system. The charger will beep twice to acknowledge the setting.

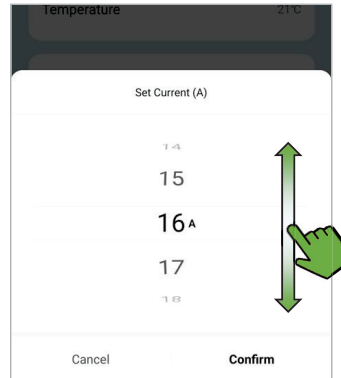

Figure 23 Maximum Charger Output Amp Selection

#### NOTES:

- To prevent sudden spikes of demand overloading the system, load balancing activates at 5A below the point set in the application.
- If load balancing is in place but not configured, the **factory default is 60A**. If the current drawn by the property and charger reaches 40A the load balancing system will decrease the amount of power available for charging in an attempt to prevent an overload of the electricity system.
- Do NOT set the load balancing figures above that of the property fuse or the maximum charging current of the charger (32A is the charger default but it may have been decreased by the installer by use of the DIP switches to prevent overloading the power supply).

### Change the Load Balancing Setting

If the figure entered into the system for load balancing is incorrect or needs to be changed it cannot be amended without removing the data from the system.

**NOTE:**

If attempting to amend the figure, the system will appear to accept the entry by beeping twice but the entry will NOT be saved.

To remove data from the system:

1. Tap the **Edit** icon shown at the top of any of the main application screens.
  - A configuration screen will be displayed.



Figure 24 Edit Icon

2. Tap Remove Device, shown at the bottom of the screen.

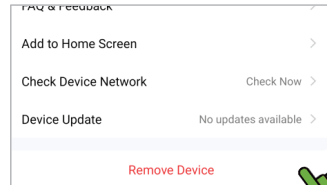

Figure 25 Remove Device

3. Tap the option to **Disconnect and wipe data**.
  - The Disconnect option will only remove the charger from the application but will not remove the data.

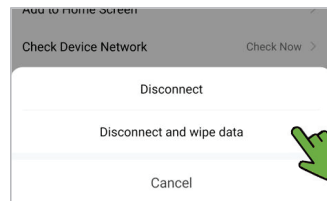

Figure 26 Disconnect and wipe data

4. A warning message will be displayed Tap **Confirm**.
  - The charger and all of its settings will be removed from the application and the initial connection screen will be shown.
  - Connection network settings should be retained.
5. Simply scan for the charger as described in **Add a Device** and re-add the charger to the application.
6. The correct load balancing figure can now be entered as described in **Configure Load Balancing** on page 28.

## OCPP IP and ID Settings

If required, the IP address of the OCPP back-office server can be set/changed. These settings must NOT be amended unless instructed to do so.

1. Make sure the OCPP IP address is correct.
2. Make sure the ID is entered exactly as shown on the OCPP server.
  - The Device number field will update to be the same as the ID on the OCPP server but may not change until the system is restarted.
3. After entering changes, exit the application then power off the charger. Restart the charger and check that the changes have taken effect.

## Operation

**IMPORTANT:** This chargepoint is designed to be used by adults only, do not allow children to operate or play with the appliance.

**NOTE:** At the end of a charging session, always disconnect the cable from the vehicle **before** disconnecting from the charger.

## Share a Connection

Only one account can be registered to a charger.

If other people (guests) also need to use the charger without the owner being present, they must have their own account with the application. The owner can then share controlled access to the charger through an 'invitation' to specific people.

1. Tap the **Pencil** icon at the top of the screen.
2. Tap the **Share Device** text.
  - If this is the first time the charger has been shared, you may be required to tap the **Add Sharing** button.
3. On the next screen, enter the number of people the access to the charger will be shared with.
4. Choose the method of sharing – this is governed by the methods of sharing already provided by your phone. Some common options may be displayed as standard. Other options will be accessible by tapping the **More** button.
  - A message with a link to access the charger will be written into the chosen sharing application.
5. When the message is received, the guest should follow the onscreen prompts to access and connect to the charger.
  - When first added, the screen may need to be refreshed for the charger to be displayed.
6. From this point you can use the chargepoint for charging, but you cannot access important settings.

If required, guest connections can be removed by either the owner or the guest.

1. Tap the **Pencil** icon at the top of the screen.



2. Tap the **Share Device** text.
  - If it is the guest removing the connection, tap the **Remove Sharing** text then tap **Confirm** to remove the connection.
  - If it is the owner removing the connection, choose the guest to be removed from the list shown on-screen. Tap the **Unshare** text then tap **Confirm** to remove the connection.







Alternatively, the owner can restrict the period that the guest can access the chargepoint using the app.

1. Tap the **Pencil** icon at the top of the screen.
2. Tap the **Share Device** text.
3. Choose the guest from the list shown on-screen.
4. Tap the **Validity Period** text.
5. Select a date in the future using the calendar wheels, then tap **Done**.
  - The guest will be able to access the charger until the end of the selected day (even if today's date is selected) and will then access will be removed.
  - The guest will still be listed, and a new period of access or permanent access can be granted (or removed) whenever it is required.









## Charger Status Indications

The charger status indicator is located on the front of the enclosure.

### Operational Indications

	<b>No Light</b>	No power to charger.
	<b>Blue, Green and Red flashing alternately</b>	Product power-on self-check.
	<b>Blue Glowing</b>	Standby.
	<b>Blue Flashing</b>	Connection confirmation
	<b>Green Glowing</b>	Charging.
	<b>Green Flashing</b>	Charging complete. Turn off charging via App or OCPP.

### Fault Indications

	<b>No Light</b>	No power to charger.		<b>Red flashing 4 fast 1 slow</b>	Over voltage fault
	<b>Red flashing 1 fast 2 slow</b>	CP fault		<b>Red flashing 6 fast 2 slow</b>	Adhesion fault
	<b>Red flashing 2 fast 1 slow</b>	Over current		<b>Red flashing 7 fast 1 slow</b>	Earth fault
	<b>Red flashing 3 fast 1 slow</b>	Leakage current fault		<b>Red Glowing</b>	Over temperature
	<b>Red flashing 3 fast 2 slow</b>	Under voltage fault			

## Charger Button Functions

The charger button is located on the left-hand side of the enclosure.

Function	Operation	Status Indication	Remarks
<b>Emergency Stop</b>	Press ONCE during normal charging	 Flashing RED light (1 fast, 1 slow)	Unplug the connector if possible.
<b>Mode Toggle</b>	<p><b>In standby state:</b></p> <ol style="list-style-type: none"> <li>Under APP controlled (Schedule) mode, press 5 times continuously to enter plug and charge mode.</li> <li>Under plug and charge mode (Manual), press 5 times continuously to switch the randomized delay on or off.</li> </ol> <p><b>NOTE:</b> Plug and charge mode automatically starts charging after the connection is confirmed.</p> <p><b>Randomized delay:</b> The unit operates with a delay of up to 600 seconds each time a charge session starts.</p>	Beep twice	If you want to cancel plug and charge mode, click schedule by APP on standby state.
<b>Wi-Fi Reset</b>	In standby state: Press and hold for more than 10 seconds to reset the Wi-Fi, then re-add the device for pairing connection on the App.	Beep twice	N/A

## Charge a Vehicle

### Charging Modes

When the application was first setup by the installer, they will have put the charger into Plug and charge mode to check charger functionality. The charger may still be in Plug and charge mode when the installer hands over to the owner/end user.

- **Plug and charge** mode allows charging to take place at any time. Charging will then start after a randomised delay of up to 10 minutes.
- **Scheduled** mode is where the vehicle may be connected to the charger but the charging session starts and stops in line with the schedule set by the user in the online application, or the default schedule that was set by the manufacturer.
- **ECO** mode is available if a solar power supply is used to supplement mains power.

To change the mode using the App;

1. Tap the **Mode** icon.
2. Select the required mode from the options shown on the screen.

Alternatively, the mode can be changed from **Schedule** to **Plug and charge** by pressing the charger button 5 times in quick succession. Repeating this action will not change the mode from Manual to Schedule. This must be done using the App.

### Plug and Charge

**NOTES:** The steps below apply when the charger is in **Plug and charge mode** – sometimes referred to as ‘plug and play’ or ‘manual mode’ which allows charging to take place whenever it is required.

Under the Plug and charge mode (selected with a tick), if turned ON, the charger will start charging when the cable is plugged in. If turned OFF, charging will only start when the **Enable** button on the home screen is tapped.

The alternative to this is **Scheduled mode** where the vehicle may be connected to the charger but the charging session starts and stops in line with the schedule set by the user in the online application.

**NOTE:** In accordance with the Smart Charging Regulations, chargers are supplied by the manufacturer with default a schedule. This may have been removed if functional check was performed as part of the installation process but can be easily reinstated with the information below of with other scheduled periods.

- **8am – 11am** and **4pm – 10pm** are currently classed as peak hours and, as standard, the charger will not start a charging session during these hours.
- There is the option during the initial setup of the charger to ignore the default schedule and the installer may have selected this option in order to perform a functional test of the charger.
- Charge point users have the option to use set their own scheduled charge sessions or to plug and charge.

1. Make sure the Charge Status Indicator is illuminated **Glowing Blue**.
2. Connect the charging cable to the vehicle.
  - After connecting to the vehicle with a non-tethered charger, the charging cable can be connected to the QUBEV charger socket.
3. The charging session will start as soon as the charger has checked its systems.
  - Also, in accordance with the Smart Charging Regulations, the charger will wait for a random time of up to 10 minutes before delivering power to the vehicle.
4. The Charge Status Indicator will illuminate **Glowing Green** when charging is in progress.
  - If the Charge Status Indicator **Flashes Green**, the vehicle battery has reached its full charge capacity and the vehicle will stop the charging process.
  - If the vehicle stops the charging process and it is found that the battery does not have a full charge, the vehicle has experienced a problem and has stopped the charging process for another reason that may need to be investigated.
5. To manually STOP charging, tap the **Turn Off** button on the application Home screen or unplug the cable from the vehicle (and then from the QUBEV charger if not a tethered model).
6. When the charging session has finished, loosely coil the cable for storage.
  - Tethered cables should be hung on the hanger with the plug securely connected to the dummy socket that is built into the hanger.
  - Plug-to-plug cables used with socket chargers should have their rubber dust caps fitted and the cable should be stored in a dry, undercover environment.

### Schedule Mode

To charge the vehicle it must be connected to the charger ready for the charge session to start. In Schedule Mode the start and stop times of charge sessions can be set.

1. Tap the **Mode** icon.
2. Select **Schedule** (if not already selected).
3. Any existing schedules will be shown as a list. If no schedules have been saved, you will be given the opportunity to create one.

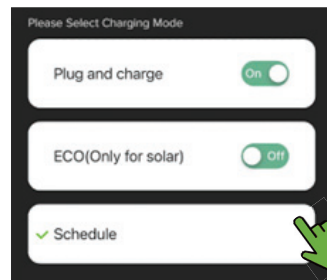

Figure 27 Setup a Schedule - 1

### Create a Schedule:

1. Tap the **Add timing** button. The scheduling screen will be displayed.
2. Set the time of when you want the charge to start using the selectors at the top of the screen.
3. If required, select a specific day of the week that this charge session will occur.
  - If a day(s) is not selected the charge session will take place every day at the same time.
4. Enter a name for the charge session that makes it easy to identify.
5. Set the Switch field to **ON**.
6. Set how long the charge session will be.
7. Tap **Save**, at the top of the screen to save the schedule.

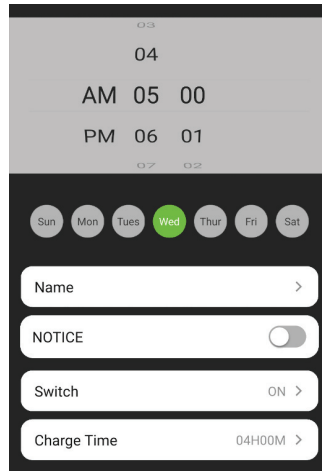

Figure 28 Setup a Schedule - 2

In the example shown above and opposite the charge session will start at 5AM on Wednesday and will last for 4 hours. The schedule will repeat each Wednesday while it is marked as being active.

If the session is marked as inactive, the charge session will not take place.

Schedules to STOP a charge session can also be created in the same way and could, for example, be used when a daily charging session needs to end early on specific day.

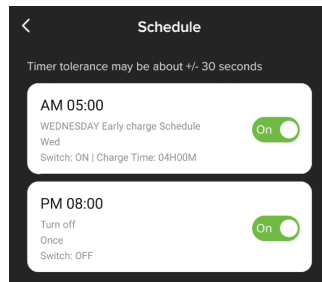

Figure 29 Schedule Set

8. To configure a 'stop' schedule set enter the times as above but set the **Switch** button to **OFF**.

If the vehicle is connected to the charger and you need to start a charging session that is not scheduled, simply tap the **Enable** button on the Home screen.

### Delete a Schedule

1. Tap the **Mode** icon then tap the **Schedule** button to open the Schedule screen.
2. Tap and hold the schedule to be deleted. You will be presented the option to Confirm deletion or cancel the action (and keep the schedule).
  - Deleted entries will be removed from the screen.

Alternatively, an active schedule can be deactivated by moving the slider switch to the left. Deactivated schedules will be 'greyed out'.

## ECO Mode

The ECO mode can be selected if the user wants to charge only by solar power. It's recommended that the solar power has an output current above 6A when selects this mode.

- If solar power is not connected to the system, do not choose ECO mode for charging.

1. A Current Transformer (CT) device must be connected between the solar system and the charger to monitor and control to supply of power to the charger from the solar system.
2. If the CT detects that the current of solar power generation is above 6A, the vehicle is charged according to the solar power generation current, and the max charging current does not exceed the max output current of the charger.

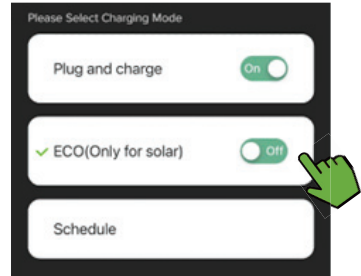

Figure 30 ECO Mode Selected

3. If the CT detects that the current of solar power generation drops under 6A, the charger will keep charging at the minimum charging current 6A to avoid car dormancy. The deficiency will be provided by the power grid.
4. Under ECO mode (selected with a tick), if turned ON, charging will start when the vehicle is connected to the charger. If turned OFF, charging will not start until the ENABLE button on the home is tapped.

### NOTES:

- Under Plug and Charge or Schedule Mode, if the CT detects the current from solar power generation, the solar power output will work as a supplement. The charger will perform the charging under the max set current by using a combination of power from the grid and power from the solar system.
- CT connections used with a solar system are only possible with single-phase models of the charger. Three-phase models already use all the available connections.
- ECO mode does not have load balancing functionality.

---

## Other Application Features

### Edit Charger Details

1. Tap the pencil icon on the Home screen to edit...

- **Device Name** – Tap the pencil icon shown next to the current charger name. The name can now be changed. (If more than 18 characters, the name will not fit on the screen).
- **Offline Notifications** – When the device is powered off, it will prompt the device to be offline on the home interface.
- **Share Device** – The charge point can be shared for use by other EV drivers according to the software, email, and account linked to the application.

**NOTE:** When using the QUBEV Smart account to share, the shared account can be added to the device with the ability to charge but without the ability to change its operation.

- **Device Update** – When software updates are available for the charge point, the application will display this and will prompt you to install the update. The update can be installed or can be ignored. If ignored, available updates can be installed at a later date from this location.
- **Remove Device** – There are options to...
  - disconnect the device.
  - disconnect and wipe data – which disconnects the device and removes the **Charging record** and the **Error Log** data.

### Record Screen

The Charging record and the Error Log can be seen from the Record screen.

---



## Maintenance

**NOTE:** In the event of a hardware issue, always contact your installer first.

- Damage caused to the equipment by misuse, lack of maintenance, inappropriate maintenance or modification is not covered by the manufacturer warranty.



**WARNING: Electrical Power**

The charger enclosure does NOT need to be opened for routine maintenance tasks but, if opened for more thorough testing/maintenance, it must only be done by an appropriately qualified electrical engineer.

1. Regularly clean the external surfaces of the equipment with a damp cloth.

**CAUTION: Equipment Damage**

To avoid damage to the surface finish, and/or internal components do NOT use:

- Abrasive materials.
- Mineral or petroleum solvents / degreasers.
- Hose pipes, Jet washers or Steam cleaners.

2. Regularly inspect the exterior of the equipment for visual damage.
  - If damage affects safety, isolate the equipment and prevent its use until appropriate repairs have been completed.

Where required, an appropriately qualified electrical engineer may open the enclosure to perform observations and tests.

3. In accordance with the legislation for the installation location, the charger and any switchgear (if installed) should be electrically inspected (tested) by an appropriately qualified electrician.
  - If the equipment fails the test, isolate the equipment and prevent its use until appropriate repairs have been completed.
  - A record of the tests and results must be kept.
4. Whenever the enclosure is opened, check the security of accessible cable terminals before closing the enclosure. Temperature changes during the year and when charging, and movement of cables during maintenance may cause cables/terminals to become loose.
  - Make sure power to the charger is OFF.
  - Check the security of ALL accessible terminals.
  - Tighten any terminals that appear loose.
5. Make sure the enclosure is closed securely after work is done.

## Disposal

In accordance with European Directive 2002/96/EC on waste electrical and electronic equipment and its implementation in national law, used electrical devices must be collected separately and recycled in an environmentally responsible manner.

Make sure you return your used device to your dealer or obtain information regarding a local, authorised collection and disposal system. Failure to comply with this EU Directive may result in a negative impact on the environment.



## Warranty

Subject to the provisions and exclusions described below, this product is designed to function for a period of at least three (3) years from the date of installation and is warranted against defects in materials, manufacturing and functionality for the same (3) year period from the date of installation. Under this warranty, parts, labour and, if required, on site assistance, will be provided free-of-charge to the customer.

Should the product fail to perform its intended purpose within the period set out above, it will be repaired or replaced with the same or a functionally equivalent product free-of-charge to the end customer or, if appropriate, free-of-charge onsite assistance will be provided.

To claim the appropriate action to be performed by the supplier...

- (1) The customer must adhere to the Warranty Claim Procedure.
- (2) The defect must be in the materials, manufacturing or functionality of the product.
- (3) The defect must not be caused by an external influence such as those shown in the **Exceptions** section of this document.
- (4) The customer must provide proof of:
  - the unit model and serial number.
  - original date of purchase.
  - the date of installation.
  - the installation certificate provided by the electrical installer.
  - product servicing/maintenance/inspection that may have been required during the period of ownership.

In line with the nature of any specific fault, remedies may include repair or replacement of components, engineering services and/or replacement of the whole product. At the manufacturer's discretion remedies may include the use of refurbished materials or components. If, by its sole determination, the manufacturer is unable to repair or replace the defective product, it may replace the product with a substantially similar model or refund the depreciated purchase price of the product. Shipping costs related to remedies will be paid by the manufacturer apart from 'not at fault' claims – Refer to the Exceptions section for details.

### Warranty Claims Procedure

- Prior to making a warranty claim the customer must contact the manufacturer to discuss the problem and any possible remedies that can be performed without the need for a formal claim.  
[sales@evonestop.co.uk](mailto:sales@evonestop.co.uk) or call +44 (0)1205 725 867.
- The manufacturer will make a record of the problem and determine whether the product meets the terms of a warranty claim (see item 4 above).
- The manufacturer will advise the customer on the most effective course of action to correct the product fault, and this may include over-the-air software updates, an engineer visit to the site, replacement of specific components, replacement of the whole product or back-to-base repair by the manufacturer.
- The manufacturer agrees that component(s) or the product should be returned or replaced, it will issue a

**Return Authorisation** number. This number must be clearly marked on the packaging of the product to be returned.

- If requested by the manufacturer, component(s) or the product must be returned to the manufacturer for the claim to be valid.

Should an issue be found with your product the manufacturer will ship the repaired/replaced products free-of-charge to any UK address. Should the return address be outside of the UK, return postage will be at the manufacturer's discretion. In all cases where the product is found NOT to be defective, shipping must be paid by the customer before products will be despatched.

### Exceptions

This warranty does not apply if:

- the proofs (listed above at item 4) cannot be supplied.
- in the judgement of the manufacturer, the product fails due to damage from storage, incorrect installation and/or configuration, accident, inappropriate use or inappropriate cleaning, relocation of the product after its first installation, abuse, misuse, or if it has been used, maintained or repaired in a manner not conforming to the manufacturer's instructions, has been modified in any way, or has had any serial number or other identification markings removed or defaced.
- the product has been repaired or maintenance has been performed by anyone other than a qualified electrician.
- it is determined that a lack of functionality or changes in functionality is related to third-party software that may be used with the product. Contact the software supplier to discuss the problem.

### Additional

Nothing in this agreement will affect the end customer's statutory rights, or limit or exclude the manufacturer's liability for (1) death or personal injury caused by its negligence, or the negligence of its employees, agents or subcontractors (as applicable); (2) fraud or fraudulent misrepresentation; (3) defective products under the Consumer Protection Act 1987; or (4) any matter in respect of which it would be unlawful for QUBEV to exclude or restrict liability.

The maximum liability of QUBEV under this warranty is limited to the purchase price of the product covered by the warranty. Components and/or products replaced under warranty adopt the remaining period of the original warranty. Components replaced at the customer's cost (outside of the main product warranty) are subject to their own warranty terms and do not have any bearing on the main product warranty.

QUBEV only supply products for resale for domestic, light commercial and private use. QUBEV accept no liability to the end customer for any loss of profit, loss of business, business interruption, loss of business opportunity or travel time incurred.



THIS DOCUMENT CONTAINS INFORMATION THAT IS SUBJECT TO CHANGE WITHOUT NOTICE.

The latest version of this publication can be downloaded at <http://qubev.co.uk>

Illustrations of the product and user interface are for marketing purposes only.

## Main Property Fuse/Circuit Breaker Rating

Rating = Amps

Brand names, logos and trademarks used herein remain the property of their respective owners. This listing of any firm or their logos is not intended to imply any endorsement or direct affiliation with ONE STOP EUROPE LTD. and is purely to demonstrate branding opportunities.

## Charge Point Output Rating

Rating = Amps

Factory Default = 32A

Options are 10A, 13A, 16A, & 32A

© 2023 by ONE STOP EUROPE LTD. All rights reserved.

QUBEVSM-V01-R4 QubEV Smart Installation & Operation Manual A5 - EN

[www.qubev.co.uk](http://www.qubev.co.uk)



### UK Office:

[sales@evonestop.co.uk](mailto:sales@evonestop.co.uk)  
[www.evonestop.co.uk](http://www.evonestop.co.uk)

One Stop Europe Ltd, Ralphs Lane, Frampton  
West, Boston, Lincolnshire, PE20 1QU

### Europe:

[sales@evonestop.com](mailto:sales@evonestop.com)  
[www.evonestop.com](http://www.evonestop.com)

Eurotech Sire System AB, Mallslingan 20A,  
187 66 TÄBY, Sweden